



Hand operated centrifuges

page 112

Microtubes and vials centrifuge

page 112

Centrifuge angle rotor for 15 ml.

page 112

Digital electronic control centrifuges

pages 113 to 115

High speed centrifuges and refrigerated

pages 116 to 132

TFT Touch screen control

Centrifuges for flasks and blood bags

page 129 to 131







Tubes of glass and plastic and buckets

page 132

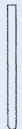

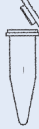
Centrifuge comparison by model and tube capacity

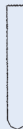











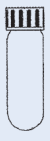



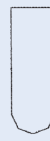

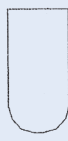

Description	Micro-haematocrit	Reaction vial	Reaction vial	Hemolysis	Glass
Capacity		0.25/0.5 ml	1.5/2.2 ml	5 ml	7 ml
Dimensions	Ø 1.4 x 75 mm	Ø 6,3/7 x 47/49 mm	Ø 10.7/13 x 42 mm	Ø 12.5 x 75 mm	Ø 12 x 100 mm
					
Description			Tube RIA	Tapval or VAC tube	
Capacity			5 ml	5 ml	
Dimensions			Ø 12 x 55/75 mm	Ø 13 x 75/80 mm	
					

SUMMARY TABLE OF CENTRIFUGES BY MODEL IN RELATION TO VOLUME, CAPACITY SPEED AND MAXIMUM RCF (G).

QUICK OVERVIEW

Model	Part No.	Max. Volume ml	Max. Volume of tube ml	R.p.m. max.	R.c.f. max. (xg)					
Manual	7000014	30	15	1500	360					
	7000015	60	15	1500	360					
	7000016	2 x butyrometer	–	1500	370					
Cencom II	7002240	90	15	4000	1760					
Centro 4-BL	7002560	20	5	5000	2907				4	
Centro 8-BL	7002356	120	15	4500	2515				8	8
Centrolit II-BL	7002357	40,5	2,2	12000	14103	24	18	18		
Centromix-BLT	7002556	150	25	12000	14200				10	4
Mixtasel-BLT	7002576	400	100	4200	2901				24 16	24
Centronic-BLT	7001768	400	100	13500	19048	24	40	30	24 16	24
Centrofriger-BLT	7001769	400	100	15300	23550	24	40	30	24 16	24
Meditronic-BLT	7001476	800	200	11000	12619					
Medifriger-BLT	7001477	800	200	15000	23470			30 48	48 28	48
Macrotronic-BLT	7001485	2000	500	10000	12296					
Macrofriger-BLT	7001486	2000	500	12000	17706			80	80 48	96
Megafriger-BLT-Blood	7001488	4000	1000	4600	5370					96
Macrofriger-BLT-Blood	7001490	9600	1600	4070	5430					144

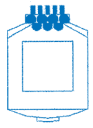
See page 132 for tubes and accessories. Tubes supplied as an accessory unless stated.

Plastic with cap	Glass	Glass	Plastic with cap	Glass	Falcon	Glass	Bottle	Glass	Bottle	Bottle	Butyrometer	ASTM	
10 ml	15 ml	25 ml	30 ml	50 ml	50 ml	100 ml	200 ml	250 ml	500 ml	1000 ml			
Ø 16.1 X 81.1 mm	Ø 16 X 100 mm	Ø 24 X 100 mm	Ø 25.3 X 92 mm	Ø 34 X 100 mm	Ø 29.5/35 X 117 mm	Ø 44/45 X 100 mm	Ø 56.5 X 104 mm	Ø 56 X 147 mm	Ø 69 X 159 mm	Ø 98/100 X 160-175 mm		Ø 58 X 158 mm	
													
Tapval or VAC tube	Falcon				Plastic with cap				Blood bag	Microtiter		ASTM	
10 ml	15 ml				80/85 ml				500/600 ml	6x96		100 ml	
Ø 16 X 100 mm	Ø 16/23 X 120 mm				Ø 38 X 112 mm					Ø 85 X 130 mm		Ø 37 X 200 mm	
													
	2												
	4										2		
	6 6												
	8												
4	8	4											
16	18 16	8	8	8	4	4							
10 16	18 16	8	8	8	4	4							
10 16	18 16	8	8	8	4	4							
20 28	28 12	8	6	8	4 6	6	4					6x96	
20 68	68 16	36	20	16	8 6	4	4	4	4			12x96	4 4
	68	36		16		8	4		4	4		4	4
	102	54		24		12	6		6 12	6			

ALL THE ROTORS, BUCKETS AND ADAPTERS COME WITH LASER ETCHED IDENTIFICATION.



Hand operated centrifuges

FEATURES

For 15 ml and butyrometer tubes.
Comes with a table holding clamp.
Adaptable heads for 2 or 4 x 15 ml tubes or for 2 butyrometer tubes.

MODELS

Part No.	Comes with head for	Max. speed r.p.m.	Max. R.c.f.	Weight Kg
7000014	2 tubes	1500	360	1.1
7000015	4 tubes	1500	360	1.2
7000016	2 butyrometers	1500	370	1.2

Comes with head and metal buckets.

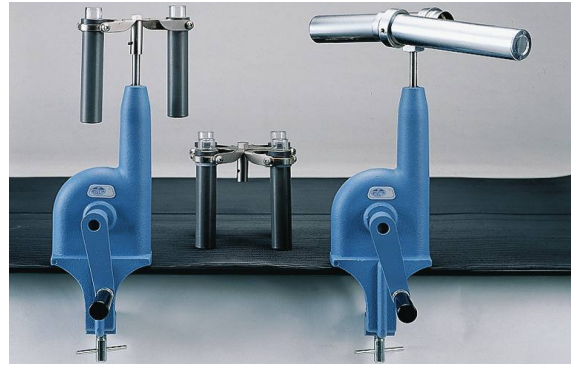

ADDITIONAL ACCESSORIES

Head for two tubes.
Part No. **7000017**
Head for four tubes.
Part No. **7001388**

Bucket for 15 ml tubes.
Part No. **7001500**
Head for two butyrometers.
Part No. **7000018**

COMECTA Microcentrifuge "Cencom III"

FOR MICROTUBES OF 2,2/1,5, 0,5 AND 0,2 ML.
DIGITAL ELECTRONIC CONTROL OF SPEED AND TIME. ADJUSTABLE SPEED UP TO 14500 r.p.m.

FEATURES

ABS external case.
Maintenance free induction drive motor.
Rubber suspended motor which reduces the vibrations.
High speed microcentrifuge that minimizes the samples over temperature.
Extremely quiet operation.
For 12 microtubes with identification code.
Polycarbonate upper lid.
Peephole on the lid to visualize the centrifuge inside.

CONTROL PANEL

Start switch.
Push button Start/Stop.
LCD display indicating time and speed.
Time selector push button.
Speed selector push button.
Push button ▲ increase different parameters.
Push button ▼ decrease different parameters.
Push button motor drive rotation for quick acceleration Short/Spin.
Push button open lid when cycle has ended.



NEW DESIGN



MODEL

Part No.	Tubes capacity	Height/ Width/ Depth (exterior) cm	Max. speed r.p.m.	R.c.f.(xg)	Power W	Time selected	Weight Kg
5022010	12	15 21 25	14500	14000	105	till 99' 99"	4

Comes complete with 12 adapters of 0,5 and 0,2ml.



Centrifuge Angle rotor "Cencom II"

WITH ANGLE ROTOR FOR 6 X 15 ml TUBES AND 6 ADDITIONAL ADAPTERS FOR 15 ML FALCON TUBES.
DIGITAL ELECTRONIC CONTROL OF SPEED AND TIME. ADJUSTABLE SPEED UP TO 4000 r.p.m. (1790 R.c.f.)

SAFETY:

SAFETY ACCORDING TO EN. 61010.2.020 SAFETY MICRO-SWITCH THAT DISCONNECTS THE POWER TO THE MOTOR WHEN THE LID IS OPENED.
PROTECTIVE FUSE LOCATED AT THE BACK OF THE INSTRUMENT.

APPLICATIONS

General laboratory use and teaching.

FEATURES

External case made from coated ABS plastic.
Rubber suspended motor, reduces any motor vibrations.
Fixed angle 6 place rotor with identification code.
Transparent polycarbonate lid that allows the user to see inside the centrifuge.
Speed selection from 1000 to 4000 r.p.m. in 500 r.p.m. steps.
Time selection from 1' to 60' in steps of 1'.

CONTROL PANEL

Digital display of speed and time.
Push button Start-Stop.
Push button selector for speed and time.
Push button increase value.
Push button decrease value.

Cross section view of the angle rotor showing bucket and bucket support.

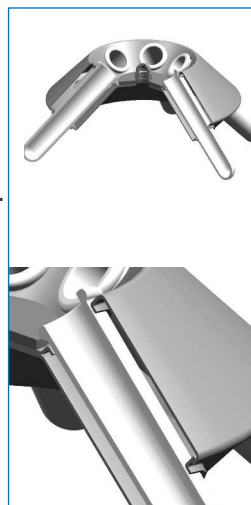

MODEL

Part No.	Tube capacity ml	Height/Ø (exterior) cm	Max. speed r.p.m.	Max. R.c.f.	Power W	Weight Kg
7002240	6 x 15	28 26	4000	1790	80	4.5

Supplied complete with 6 x 15 ml tubes with adapters and 6 adapters for 15 ml Falcon tubes.

ACCESSORY

Adapter. Suitable for 13 Ø x 75 mm VAC tubes.
Rotor capacity, 6 adapters.
Part No. **1001556**



Digital microprocessor controlled Centrifuges, Series BL and BLT

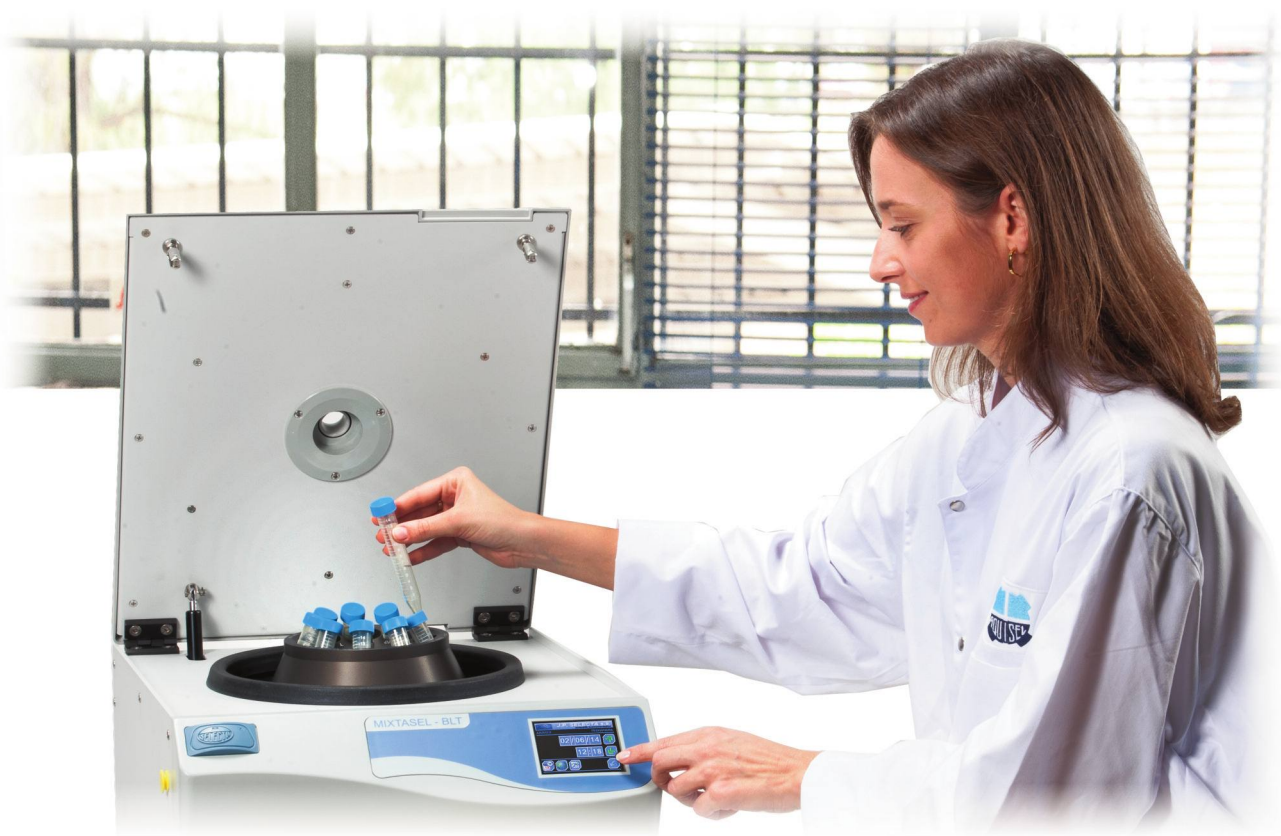

- INDUCTION DRIVE, MAINTENANCE FREE (NO CARBON BRUSHES).
- SPEED CONTROL BY VARIATOR FREQUENCY SYSTEM.
- RELIABLE FUNCTIONS AND REPEATABILITY.
- LOGICAL EASY TO USE CONTROL PANEL.
- SUSPENDED, DAMPENED VIBRATION FREE MOTOR DRIVE, GUARANTEES SMOOTH OPERATION.
- QUIET OPERATION, INTERNAL INSULATION WHICH ABSORBS NOISE AND VIBRATIONS.
- SUCTION SUPPORT FEET THAT PREVENTS BENCH CREEP.

SAFETY:
 AUTOMATICALLY STOPS IF OUT OF BALANCE.
 LID CANNOT BE OPENED IF THE MOTOR IS RUNNING.
 SYSTEM CANNOT BE STARTED IF THE LID IS OPEN.
 SPEED LIMITED BY EACH ROTOR.

TWO DIFFERENT CONTROL SYSTEMS:

A Digital display and **B** TFT touch screen

CENTROLIT II-BL - CENTRO 4-BL - CENTRO 8-BL



Specific functions of models with digital screen:

- Electronic control of speed.
- Electronic control of time.



CENTROMIX BLT - MIXTASEL BLT - CENTRONIC BLT - CENTROFRIGER BLT - MEDITRONIC BLT - MEDIFRIGER BLT - MACROTRONIC BLT - MACROFRIGER BLT - MACROFRIGER BLT-BLOOD

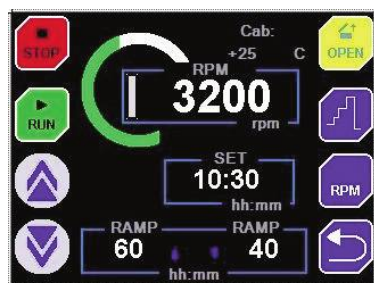

Specific functions of models with touch screen:

- Acoustic and visual alarm
- 10 working programs with 4 parameters for each program: acceleration, braking, rpm, time.
- Network failure detection and storage.
- Safety thermostat (refrigerated models only).
- Temperature correction (refrigerated models only).

- Languages: Spanish, English and French.
- Overtemperature and Low temperature alarm.
- Rotors list available on screen.
- Door open alarm.
- Rotor and motor running hours log.





CENTRIFUGES ELECTRONIC DIGITAL CONTROL “Centrolit II-BL”, “Centro-4-BL”, “Centro-8-BL”, With induction drive maintenance free motor.

SAFETY:

UNE-EN 61010.2.020. ELECTROMAGNETIC LID LOCK, PREVENTS THE OPENING OF THE CENTRIFUGE IF THE ROTOR IS IN MOTION. PREVENTS THE STARTING OF THE MOTOR IF THE LID IS OPEN. ROTOR AND BUCKETS ARE IDENTIFIED BY LASER SIGNAL. AUTOCLAVABLE.

COMMON FEATURES

Electronic control with digital display of speed and time, with acceleration and brake ramp.

Timer controllable from 1' to 60' or continuous operation.

Rubber suspended motor that guarantees a smooth operation.

Digital speed display.

Pulse button, that drives the motor while pressed.

Automatic stop if out of balance, with indicator light.

Suction base supports that adhere to the work bench surface.

Quiet operation, insulated interior that absorbs noise and vibrations.

In the case of mains failure, manual open override aperture.

Noise level 50-60dBA.

Rotors and buckets with laser identification.

Autoclavable.

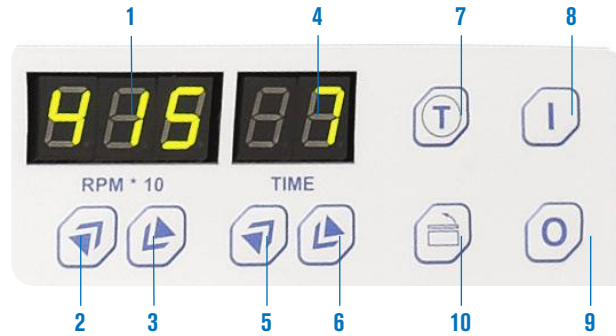

CONTROL PANEL

1. Speed display.
2. Push button increase speed.
3. Push button reduce speed.
4. Run Time display.
5. Push button increase run time.
6. Push Button decrease run time.
7. Push button pulse start (RUN/STOP).
8. Push button start.
9. Push button stop.
10. Push button open lid.



Centrifuge “Centrolit II-BL”

SUITABLE FOR HAEMATOCRIT AND SMALL VIALS OF 0.25/0.5 ml AND TUBES OF 1.5/2.2 ml.
FREE MAINTENANCE INDUCTION DRIVE MOTOR.



ABS plastic moulded external case.

MODEL

Part No.	Max. Volume ml	Max. Number of tubes	Height / Width / Depth (exterior) cm	Power W	Weight Kg
7002357	66.6	18 x 1.5 / 2.2 ml	20 28 34	200	6.5

SPARES. Tubes (see page 132).

ACCESSORIES

Interchangeable rotors made of hardened anodised aluminium. Autoclavable.

Part No. head	Rotor type	Volume rotor	Tube capacity maximum	Max. R.p.m.	Max. R.c.f. (xg)
7001704	Angle+lid	Micro-haematocrit	24 x 1.4 mm Ø	12000	13143
7001703	Angle+lid	40.5 ml	18 x 0.25/0.5 ml + 18 x 1.5/2.2 ml	12000	14103
7001702	Angle PCR	6,4 ml	32 x 0.2 mm Ø	12000	9395

Angle rotors supplied without tubes.

Micro-haematocrit rotor supplied with one box of 100 tubes.

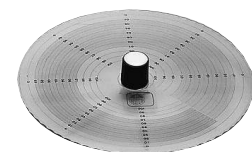

Micro-haematocrit reader.
Suitable for micro-haematocrit rotor 7001704.
Part No. **7000929**



Centrifuge "Centro-4-BL"

WITH SWINGOUT HEAD FOR 4 TUBES OF 75 X 13 mm VAC.
FREE MAINTENANCE INDUCTION DRIVE MOTOR.



Control panel features (see page 113).

Centrifuge kit for separating plasma rich platelets from whole blood.

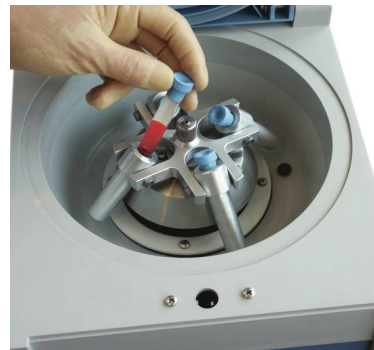

MODEL

Part No.	Height / Width / Depth (exterior) cm	Power W	Max. R.p.m.	Max. R.c.f. (xg)	Weight Kg
7002560	20 28 34	170	5000	2600	6

Rotor comes without tubes.

ABS plastic moulded external case.



Centrifuge "Centro-8-BL"

WITH ANGLE ROTOR FOR 7-15 ml TUBES AND 75 X 13 mm VAC (WITH ADAPTERS).
FREE MAINTENANCE INDUCTION DRIVE MOTOR.



Control panel features (see page 113).



ABS plastic moulded external case

MODEL

Part No.	Max. Volume ml.	Tube capacity	Height / Width / Depth (exterior) cm	Power W	Max. R.p.m.	Max. R.c.f. (xg)	Weight Kg
7002356	120	8 x 15 ml	20 28 34	170	4500	2015	6.5

Supplied complete with 8 x 15 ml glass tubes.

ACCESSORIES

Bucket adapter for 7 ml tubes.

Rotor capacity: 8 adapters.

Part No. **7000700**

Bucket adapter for 75 x 13 mm VAC. tubes.

Rotor capacity: 8 adapters.

Part No. **1001557**

SPARES. Tubes (see page 132).



MICROPROCESSOR CONTROLLED CENTRIFUGES “Centromix BLT”, “Mixtassel BLT”, “Centronic BLT” and “Centrofriger BLT”

COMMON FEATURES

Robust all metal construction:

- External case made from DUR-Al alloy.
- Internal bowl and top plate all stainless steel
- Internal steel safety chamber within the case.

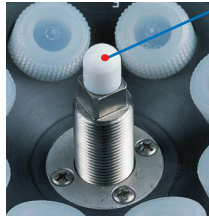

Rotor identification head (only models “Centronic BLT” and “Centrofriger BLT”) when the centrifuge lid is closed the rotor communicates all the data of the functions of it. This prevents, before use, any risk of failure of using the wrong rotor in a program or exceeding the rotors running parameters. The advantage of this system is that we can add additional rotors to the range without changing the centrifuge model.

Electronic circuits, microprocessor digital control of all parameters and functions: speed, acceleration, brake, RCF, temperature, timer, 10 program storage, automatic rotor recognition and alarm system.

Induction drive maintenance free motor.

Low noise level 50-60 dBa.

Rotors, buckets and adapters are identified with an inalterable engraved laser code.

Air circulation system, to limit any excessive rise in temperature within the centrifuge, all air circulated within the chamber is channelled out of the back and is not re-circulated, this means that the centrifuges internal temperature will remain low and constant.

Hermetically sealed compressor, mounted on anti-vibration mounts with re-circulating evaporator around the centrifuge chamber. (only applies to refrigerated centrifuges).

CONTROL PANEL

TFT Touch screen

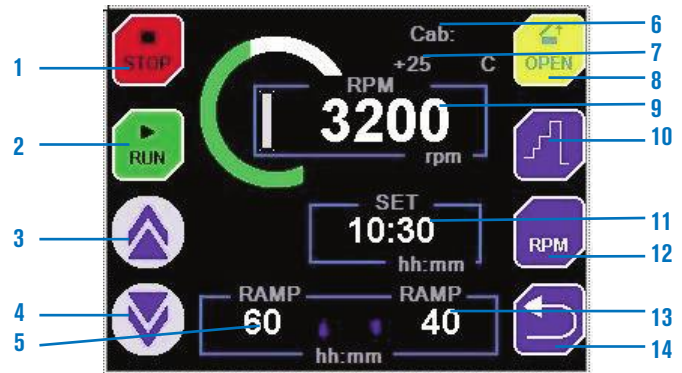

1. Stop process key.
2. Start process key.
3. Increase value key.
4. Decrease value key.
5. Scheduled acceleration ramp.
6. Rotor model in use.
7. Reading the real time temperature. (refrigerated models only).
8. Door opening key.
9. RPM or RCF real-time reading.
10. Sequential operation.
11. Time set-up in process.
12. Key to change RPM / RCF.
13. Braking ramp programmed.
14. Return key.



Centrifuge “Centromix BLT”

WITH A CHOICE OF ROTORS AND INTERCHANGEABLE ADAPTERS.
FREE MAINTENANCE INDUCTION DRIVE MOTOR.



HEAD AND BUCKET REDUCERS

Reducers for bucket. Part No. 7001066:

- 7001813** For 1 tube 15 ml (16,5 Ø x 100 mm).
- 7001814** For 1 tube 10 ml (16 Ø x 80 mm).
- 7001815** For 1 tube 7 ml (12 Ø x 100 mm).
- 7001816** For 1 tube 5 ml (12,5 Ø x 75 mm).

Reducers for bucket. Part No. 7001067:

- 1001557** For 1 tube 5 ml (12,5 Ø x 75 mm).

Reducers for head. Part No. 7000555:

- 7000700** For 1 tube 7 ml (12 Ø x 100 mm) Sheath.
- 1001557** For 1 tube 5 ml (12,5 Ø x 75 mm).

MODEL

Part No.	Max. Volume ml	Max. Number of tubes	Height / Width / Depth (exterior) cm	Power W	Weight Kg
7002556	120	4 x 25 ml	23 30 35	180	12

External DUR-AL case, with AISI 304 stainless steel bowl.

ACCESSORIES Rotors and interchangeable buckets and adapters.

Part No. head	Rotor type	Part No. bucket	Total max. Volume (4 adapters)	Bucket/Adapter capacity	Ø x Length mm	Max. R.p.m.	Max. R.c.f. (xg)
7000555	Angle	-	150 ml	10 x 15 ml	16.5 x 100	4400	1850
	Swing out	7001066	100 ml	1 x 25 ml	24 x 100	4400	2705
	Swing out	7001067	60 ml	1 x 15 ml	16.5 x 100	4400	2705
7001065	Swing out	7001068	28 ml	1 x 7 ml	12 x 100	4400	2705
	Swing out	7001573	40 ml	2 x 5 ml VAC	13 x 75	4400	2335
	Swing out	7001070	60 ml	VAC	16 x 100	4400	2790
	Swing out	7001072	-	undrilled	-	4400	2705

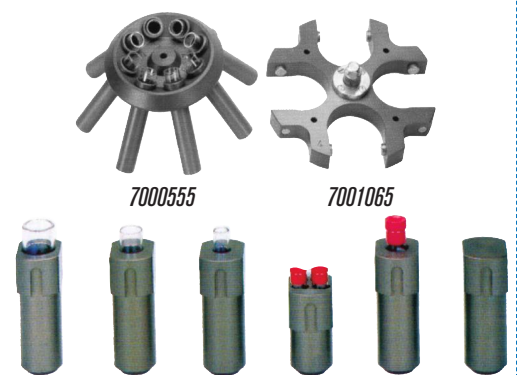

Note: All buckets and adapters come without tubes unless stated, see page 132 for tubes and accessories.



Centrifuge "MixtaseL-BLT"

MAINTENANCE FREE INDUCTION DRIVE MOTOR.

Polyvalent with rotors and interchangeable adapters

Control panel features (see page 116).



External case of DUR-AL alloy with ABS plastic coated front AISI 304 stainless steel bowl.

MODEL

Part No.	Max. Volume ml	Max. Number of tubes	Height / Width / Depth (exterior) cm	Power W	Weight Kg
7002576	400	4 x 100 ml	34 41 54	210	22

ACCESSORIES

Swing out rotor with interchangeable sealed buckets and adapters, each with identification code. Autoclavable.



Part No. head	Rotor type	Bucket open	Sealed bucket	Part No. adapter	Total max. Volume (4 adapters)	Bucket/Adapter capacity	Ø x Length mm	Max. R.p.m.	Max. R.c.f. (xg)
	Swing out	7000731	7000732	7000734	200 ml	1 x 50 ml	34 x 100	4200	4137
	Swing out	7000731	7000732	7000735	200 ml	2 x 25 ml	24 x 100	4200	4137
	Swing out	7000731	7000732	7000736	420 ml	7 x 15 ml and VAC*	16.5 x 100	4200	4137
7009079	Swing out	7000731	7000732	7001647	240 ml	6 x 10 ml	17 x 110	4200	4137
	Swing out	7000731	7000732	7000737	336 ml	12 x 7 ml	12 x 100	4200	4137
	Swing out	7000731	7000732	7000738	240 ml	12 x 5 ml	12.5 x 75	4200	4137
	Swing out	7000731	7000732	7001648	140 ml	7 x 5 ml and VAC*	13 x 75	4200	4137
	Swing out	7000731	7000732	7000739	144 ml	12 x 3 ml	11 x 100	4200	4137
	Swing out	7000731	7000732	7000740	-	undrilled	-	4200	4137
7000612	Swing out	-	-	-	-	4 x 96 microtiter	-	4200	1719

*VAC: Blood tube with stopper.

** Bucket Part No. 7000731 accommodate 1 x 200 ml polypropylene bottle with cap without the need of an adapter.

Note: All buckets and adapters come without tubes unless stated, see page 132 for tubes and accessories.

ACCESSORIES

Interchangeable angle rotors with lids, made of hardened anodised aluminium. Rotors come with identification system. Autoclavable rotors and buckets.

Part No. head	Rotor type	Max. volume	Tube capacity	Ø x Length mm	Max. R.p.m.	Max. R.c.f. (xg)
7001705	Angle+lid	270 ml	18 x 15 ml	16.5 x 100	4200	1893
7001711	Angle+lid	400 ml	8 x 50 ml	34 x 100	4200	1921
7001342	Angle+lid	360 ml	24 x 15 ml	16,5 x 100	4200	1893

Note: All buckets and adapters come without tubes unless stated, see page 132 for tubes and accessories.



7001705



7001711



7001342

Swing out rotor, interchangeable buckets and adapters each with identification code. Autoclavable.

BUCKETS

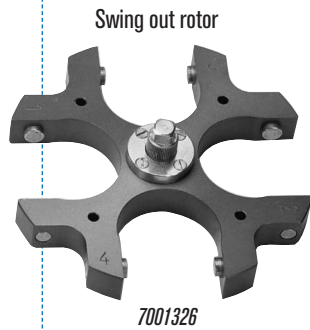

Swing out rotor

7001326



7001700



7000793



7000794



7000795



7000796



7000797



7000930



7000931



7001073



7001074



7000798

ADAPTERS



7001315

Sealed bucket with hermetically sealed lid.



7001316



7001317



7001318



7001319



7001320



7001321



7001322

Part No. Rotor	Rotor type	Part No. bucket	Sealed bucket	Part No. adapter	Total max. Volume (4 adapters)	Bucket/Adapter capacity	Ø x Length mm	Max. R.p.m.	Max. R.c.f. (xg)
	Swing out	7001700	-	-	400 ml	1 x 100 ml	44 x 104	4200	3030
	Swing out	7000793	-	-	200 ml	1 x 50 ml	34 x 100	4200	3030
	Swing out	7000794	-	-	100 ml	1 x 25 ml	24 x 100	4200	3030
	Swing out	7000795	-	-	240 ml	4 x 15 ml	16.5 x 100	4200	3030
	Swing out	7000796	-	-	140 ml	5 x 7 ml	12 x 100	4200	3030
	Swing out	7000797	-	-	100 ml	5 x 5 ml	12.5 x 75	4200	2441
	Swing out	7000930	-	-	240 ml	4 x 15 ml Falcon	16.5 x 120	4200	3030
	Swing out	7000931	-	-	200 ml	1 x 50 ml Falcon	30 x 117	4200	3030
	Swing out	7001073	-	-	16 VAC	4 VAC*	16 x 100	4200	3030
7001326	Swing out	7001074	-	-	16 VAC	4 VAC*	13 x 75	4200	2441
	Swing out	7000798	-	-	undrilled	-	-	4200	3030
	Swing out	-	7001315	100 ml glass tube**	400 ml	1 x 100 ml	44 x 104	4200	2901
	Swing out	-	7001315	7001316	200 ml	1 x 50 ml	34 x 100	4200	2901
	Swing out	-	7001315	7001317	100 ml	1 x 25 ml	24 x 100	4200	2901
	Swing out	-	7001315	7001318	240 ml	4 x 15 ml	16.5 x 100	4200	2901
	Swing out	-	7001315	7001319	140 ml	5 x 7 ml	12 x 100	4200	2901
	Swing out	-	7001315	7001320	100 ml	5 x 5 ml	12.5 x 75	4200	2901
	Swing out	-	7001315	7001321	64 ml	4 VAC*	13 x 75	4200	2901
	Swing out	-	7001315	7001322	undrilled	-	-	4200	2901

*VAC(r): Blood tube with cap (bung). **Sealed bucket Part No. 7001315 accommodates a 100 ml glass tube without the need of an adapter.

Note: All buckets and adapters come without tubes unless stated, see page 132 for tubes and accessories.

HEAD AND BUCKET REDUCERS

Reducers for head. Part No. **7001711**:

7001707 For 1 tube 50 ml (29 Ø x 103 mm).

7001708 For 1 tube 25 ml (24 Ø x 100 mm).

7001709 For 1 tube 30 ml (25 Ø x 92 mm).

7001710 For 1 tube 15 ml (16,5 Ø x 100 mm).

7001780 For 1 tube 10 ml (16 Ø x 80 mm).

7001781 For 4 tubes 7 ml (12 Ø x 100 mm).

7001782 For 4 tubes 5 ml (12,5 Ø x 75 mm).

Reducers for bucket. Part No. **7001700**:

7001779 for 1 tube 85 ml (38 Ø x 112 mm).



High speed centrifuges with microprocessor control "Centronic BLT" and "Centrofriger BLT"



Versatile. Large range of rotors and adapters. Maintenance free induction motor drive.



Model "Centronic BLT"

MODEL

Part No.	Max. Volume ml	Max. number of tubes	Height / Width / Depth (exterior) cm	Power W	Weight Kg
7001768	400	4 x 100 ml	34 41 54	440	22

Control panel features (see page 116).

External case of DUR-AL alloy with ABS plastic coated front AISI 304 stainless steel bowl.



Model "Centrifriger BLT" refrigerated, temperature range -12 °C to 40 °C.

MODEL

Part No.	Max. Volume ml	Max. number of tubes	Height / Width / Depth (exterior) cm	Power W	Weight Kg
7001769	400	4 x 100 ml	34 41 71	960	39

Note: The rotor being used limits the actual temperature in the chamber due to the speed and ambient temperature. Internal temperature indicated on the LCD display.

ACCESSORIES

Angle rotors with lid, made of anodised hardened aluminium with identification system. All rotors are autoclavable.



Part No. head	Rotor type	Max. volume	Tubes capacity	Ø x Length mm	CENTRONIC BLT		CENTROFRIGER BLT	
					Max. R.p.m	Max. R.c.f. (xg)	Max. R.p.m	Max. R.c.f. (xg)
7001670	Angle+lid	270 ml	18 x 15 ml	16.5 x 100	4200	1893	4200	1893
7001706	Angle+lid	400 ml	8 x 50 ml	34 x 100	6000	3920	6000	3920
7001325	Angle+lid	500 ml	6 x 50 ml	29 x 103	6000	3920	6000	24204
7001324	Angle+lid	180 ml	6 x 30 ml	25 x 92	13500	16900	15300	20410
7001323	Angle+lid	100 ml	10 x 10 ml	16 x 80	13500	18335	15300	23550
7001671	Angle+lid	40.5 ml	18x0.25/0.5 ml + 18x1.5/2.2 ml	-	13500	15992	15300	20541
7001672	Angle+lid	60 ml	40 x 0.25/0.5 ml	-	13500	16250	15000	20100
7001673	Angle+lid	45 ml	30 x 1.5/2.2 ml	-	13500	19048	15000	23716
7001408	Angle+lid	Microhaematocrit	24	1.4 x 75	12000	15935	12000	15935

Note: All buckets and adapters come without tubes unless stated, see page 132 for tubes and accessories.

ACCESSORIES

Swing out rotor with interchangeable sealed buckets and adapters, each with identification code. Autoclavable.



Part No. head	Rotor Type	Part No. bucket	Sealed bucket	Part No. adapter	Total max. Volume (4 adapters)	Bucket/Adapter capacity	Ø x Length mm	Max. R.p.m.	Max. R.c.f. (xg)	
7001407	Swing out	7001700	-	-	400 ml	1 x 100 ml	44 x 104	5000	4137	
	Swing out	7000793	-	-	200 ml	1 x 50 ml	34 x 100	5000	4137	
	Swing out	7000794	-	-	100 ml	1 x 25 ml	24 x 100	5000	4137	
	Swing out	7000795	-	-	240 ml	4 x 15 ml	16.5 x 100	5000	4137	
	Swing out	7000796	-	-	140 ml	5 x 7 ml	12 x 100	5000	4137	
	Swing out	7000797	-	-	100 ml	5 x 5 ml	12.5 x 75	5000	3318	
	Swing out	7000930	-	-	240 ml	4 x 15 ml Falcon	16.5 x 120	5000	4109	
	Swing out	7000931	-	-	200 ml	1 x 50 ml Falcon	30 x 117	5000	4109	
	Swing out	7001073	-	-	16 VAC	4 VAC*	16 x 100	5000	4137	
	Swing out	7001074	-	-	16 VAC	4 VAC*	13 x 75	5000	3318	
	Swing out	7000798	-	-	undrilled	-	-	5000	4137	
	Swing out	-	7001315	100 ml glass tube**	-	400 ml	1 x 100 ml	44 x 104	5000	4137
	Swing out	-	7001315	7001316	-	200 ml	1 x 50 ml	34 x 100	5000	4137
	Swing out	-	7001315	7001317	-	100 ml	1 x 25 ml	24 x 100	5000	4137
	Swing out	-	7001315	7001318	-	240 ml	4 x 15 ml	16.5 x 100	5000	4137
	Swing out	-	7001315	7001319	-	140 ml	5 x 7 ml	12 x 100	5000	4137
	Swing out	-	7001315	7001320	-	100 ml	5 x 5 ml	12.5 x 75	5000	4137
	Swing out	-	7001315	7001321	-	64 ml	4 VAC*	13 x 75	5000	4137
	Swing out	-	7001315	7001322	-	undrilled	-	-	5000	4137

*VAC(r): Blood tube with cap.

**Sealed bucket Part No. 7001315 accommodates a 100 ml glass tube without the need of an adapter.

Micro-haematocrit rotor comes with a box of 100 tubes and calculus graph.

Note: All buckets and adapters come without tubes unless stated, see page 132 for tubes and accessories.

HEAD AND BUCKET REDUCERS

Reducers for head. Part No. 7001706:

7001707 For 1 tube 50 ml (29 Ø x 103 mm).

7001708 For 1 tube 25 ml (24 Ø x 100 mm).

7001709 For 1 tube 30 ml (25 Ø x 92 mm).

7001710 For 1 tube 15 ml (16,5 Ø x 100 mm).

7001780 For 1 tube 10 ml (16 Ø x 80 mm).

7001781 For 4 tube 7 ml (12 Ø x 100 mm).

7001782 For 4 tube 5 ml (12,5 Ø x 75 mm).

Reducers for head. Part No. 7001325:

7001791 For 1 tube 25 ml (24 Ø x 100 mm).

7001792 For 1 tube 30 ml (25 Ø x 92 mm).

7001793 For 1 tube 15 ml (16,5 Ø x 100 mm).

7001794 For 1 tube 10 ml (16 Ø x 80 mm).

7001795 For 2 tubes 7 ml (12 Ø x 100 mm).

7001796 For 2 tubes 5 ml (12,5 Ø x 75 mm).

Reducers for head. Part No. 7001324:

7001797 For 1 tube 15 ml (16,5 Ø x 100 mm).

7001798 For 1 tube 10 ml (16 Ø x 80 mm).

7001799 For 1 tube 7 ml (12 Ø x 100 mm).

7001800 For 1 tube 5 ml (12,5 Ø x 75 mm).

Reducers for head. Part No. 7001670:

7000700 For 1 tube 7 ml (12 Ø x 100 mm).

1001557 For 1 tube 5 ml (12,5 Ø x 75 mm).

Reducers for head. Part No. 7001323:

7001801 For 1 tube 5 ml (12,5 Ø x 75 mm).

Reducers for bucket. Part No. 7001700:

7001779 For 1 tube 85 ml (38 Ø x 112 mm).

ACCESSORIES

Swing out rotor with interchangeable sealed buckets and adapters, each with identification code. Autoclavable.



Part No. head	Rotor type	Bucket open	Sealed bucket	Part No. adapter	Total max. Volume (4 adapters)	Bucket/Adapter capacity	Ø x Length mm	Max. R.p.m.	Max. R.c.f. (xg)
	Swing out	7000731	7000732	7000734	200 ml	1 x 50 ml	34 x 100	5000	4200
	Swing out	7000731	7000732	7000735	200 ml	2 x 25 ml	24 x 100	5000	4200
	Swing out	7000731	7000732	7000736	420 ml	7 x 15 ml and VAC*	16.5 x 100	5000	4200
7009079	Swing out	7000731	7000732	7001647	240 ml	6 x 10 ml	17 x 110	5000	4200
	Swing out	7000731	7000732	7000737	336 ml	12 x 7 ml	12 x 100	5000	4200
	Swing out	7000731	7000732	7000738	240 ml	12 x 5 ml	12.5 x 75	5000	4200
	Swing out	7000731	7000732	7001648	140 ml	7 x 5 ml and VAC*	13 x 75	5000	4200
	Swing out	7000731	7000732	7000739	144 ml	12 x 3 ml	11 x 100	5000	4200
	Swing out	7000731	7000732	7000740	-	undrilled	-	5000	4200
7000613	Swing out	-	-	-	-	4 x 96 microtiter	-	4200	1719

*VAC: Blood tube with stopper.

** Bucket part nos. 7000731 and 7000732 accommodate 1 x 200 ml polypropylene bottle with cap without the need of an adapter.

Note: All buckets and adapters come without tubes unless stated, see page 132 for tubes and accessories.



Microprocessor controlled centrifuges “Meditronic BLT”, “Medifriger BLT”, “Macrotronic BLT” and “Macrofriger BLT”



COMMON FEATURES

Induction drive maintenance free motor.

Low noise level 50-60dBa.

Robust all metal construction:

-External case made from DUR-Al alloy.

-Internal bowl and top plate all stainless steel

-Internal steel safety chamber within the case.

Electronic circuits, microprocessor digital control of all parameters and functions: speed, acceleration, brake, RCF, temperature, timer, 10 program storage, automatic rotor recognition and alarm system.

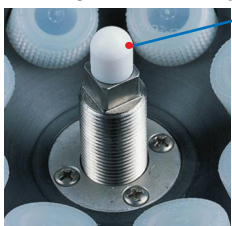

Rotor identification head, when the centrifuge lid is closed the rotor communicates all the data of the functions of it. This prevents, before use, any risk of failure of using the wrong rotor in a program or exceeding the rotors running parameters. The advantage of this system is that we can add additional rotors to the range without changing the centrifuge model.

All Rotors, buckets and adapters are identified with an inalterable engraved laser code.

Air circulation system, for centrifuges without refrigeration to limit any excessive rise in temperature within the centrifuge, all air circulated within the chamber is channelled out of the back and is not re-circulated, this means that the centrifuges internal temperature will remain low and constant.

Hermetically sealed compressor, mounted on anti-vibration mounts with re-circulating evaporator around the centrifuge chamber. (only applies to refrigerated centrifuges).

CONTROL PANEL

Touch screen

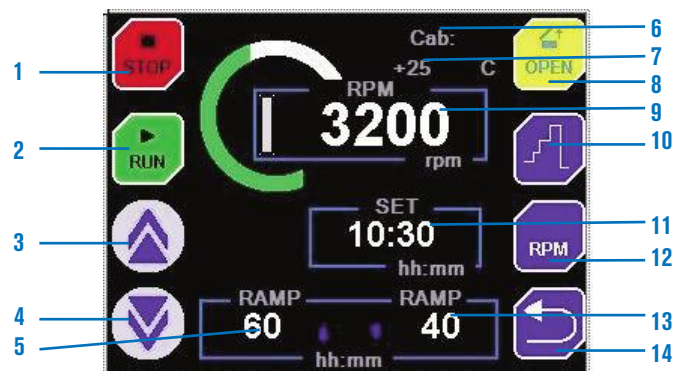

1. Stop process key.
2. Start process key.
3. Increase value key.
4. Decrease value key.
5. Scheduled acceleration ramp.
6. Rotor model in use.
7. Reading the real time temperature. (refrigerated models only).
8. Door opening key.
9. RPM or RCF real-time reading.
10. Sequential operation.
11. Time set-up in process.
12. Key to change RPM / RCF.
13. Braking ramp programmed.
14. Return key..



High speed centrifuges with microprocessor control “Meditronic-BLT” and “Medifriger-BLT”



Capacity up to 800 ml. Maintenance free induction motor drive.



Control panel features (see page 121).
External case made of DUR-AL alloy with an AISI 304 stainless steel bowl.



Model “Meditronic-BLT”

MODEL

Part No.	Max. Volume ml	Max. Number of tubes	Height / Width / Depth (exterior) cm	Power W	Weight Kg
7001476	800	4 x 200 ml	38 46 52	520	44

Model “Medifriger-BLT” refrigerated, temperature range -12 °C to 40 °C.

MODEL

Part No.	Max. Volume ml	Max. Number of tubes	Height / Width / Depth (exterior) cm	Power W	Weight Kg
7001477	800	4 x 200 ml	38 68 52	1230	70

Note: The rotor being used limits the actual temperature in the chamber due to the speed and ambient temperature. Internal temperature indicated on the LCD display.

ACCESSORIES

Angle rotors with lid, made of anodised hardened aluminium with identification system. All rotors are autoclavable.



Part No. head	Rotor type	Max. volume	Tube capacity	Ø x Length mm	MEDITRONIC BLT		MEDIFRIGER BLT	
					Max. R.p.m	Max. R.c.f. (xg)	Max. R.p.m	Max. R.c.f. (xg)
7000741	Angle+lid	600 ml	6 x 100 ml	44 x 104	4500	3170	4500	3170
7000742	Angle+lid	400 ml	8 x 50 ml	34 x 100	4600	3075	4600	3075
7000743	Angle+lid	360 ml	24 x 15 ml	16.5 x 100	4800	3761	4800	3761
7001449	Angle+lid	510 ml	6 x 85 ml	38 x 105	8000	6868	12000	15455
7001448	Angle+lid	400 ml	8 x 50 ml	29 x 103	8000	7802	12000	15938
7001447	Angle+lid	180 ml	6 x 30 ml	25 x 92	9000	7424	14000	17965
7001446	Angle+lid	200 ml	20 x 10 ml	16 x 80	9000	8964	12000	15997
7001445	Angle+lid	100 ml	10 x 10 ml	16 x 80	9000	7293	15000	20124
7001444	Angle+lid	45 ml	30 x 1.5/2.2 ml	-	11000	12619	15000	23470

Note: All buckets and adapters come without tubes unless stated, see page 132 for tubes and accessories.

ACCESSORIES

Swing out rotor with interchangeable sealed buckets and adapters, each with identification code. Autoclavable.

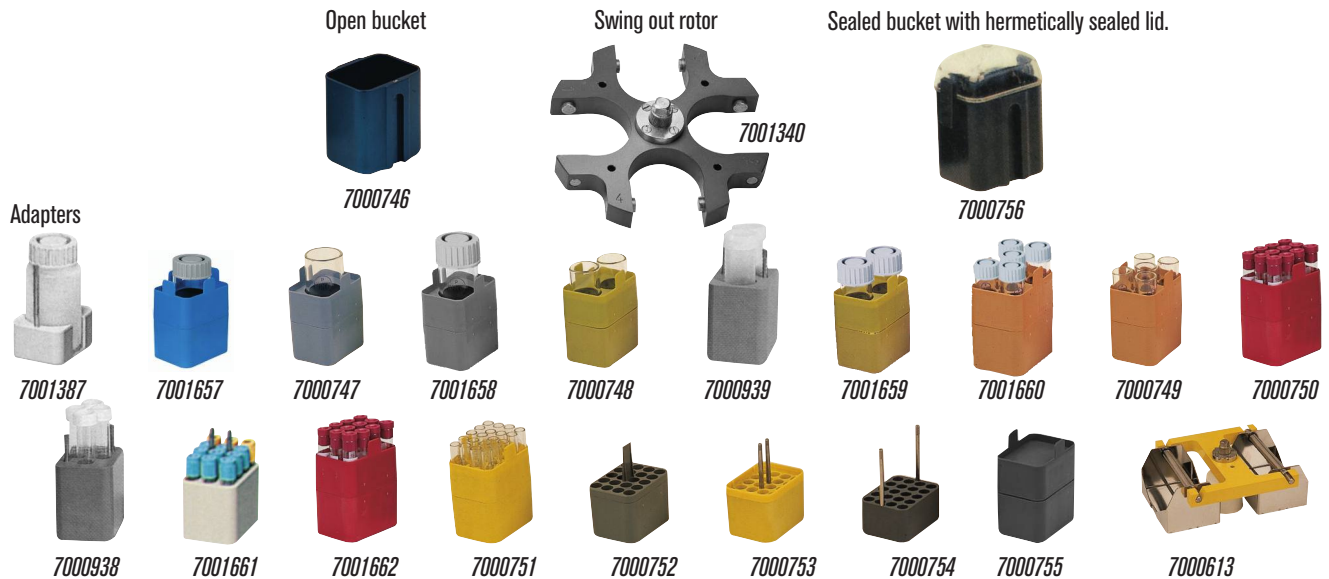

Part No. head	Rotor type	Bucket open	Sealed bucket	Part No. adapter	Total max. Volume (4 adapters)	Bucket/Adapter capacity	Ø x Length mm	Max. R.p.m.	Max. R.c.f. (xg)
7001340	Swing out	7000746	7000756	7001387	800 ml	1 x 200 ml	56.6 x 104	5000	4312
	Swing out	7000746	7000756	7001657	500 ml	1 x 125 ml	51 x 115	5000	4312
	Swing out	7000746	7000756	7000747	400 ml	1 x 100 ml	44 x 104	5000	4312
	Swing out	7000746	7000756	7001658	320 ml	1 x 80 / 85 ml	38 x 105	5000	4312
	Swing out	7000746	7000756	7000748	400 ml	2 x 50 ml	34 x 100	5000	4312
	Swing out	7000746	7000756	7000939	400 ml	2 x 50 ml Falcon	30 x 117	5000	4312
	Swing out	7000746	7000756	7001659	400 ml	2 x 50 ml	29 x 103	5000	4312
	Swing out	7000746	7000756	7001660	600 ml	5 x 30 ml	25 x 92	5000	4312
	Swing out	7000746	7000756	7000749	500 ml	5 x 25 ml	24 x 100	5000	4312
	Swing out	7000746	7000756	7000750	720 ml	12 x 15 ml	16.5 x 100	5000	4312
	Swing out	7000746	7000756	7000750	720 ml	12 VAC*	16.5 x 100	5000	4312
	Swing out	7000746	7000756	7000938	240 ml	4 x 15 ml Falcon	16.5 x 120	5000	4312
	Swing out	7000746	7000756	7001661	-	12 VAC*	13 x 75	5000	4312
	Swing out	7000746	7000756	7001662	480 ml	12 x 10 ml	16.8 x 85	5000	4312
	Swing out	7000746	7000756	7000751	560 ml	20 x 7 ml	12 x 100	5000	4312
	Swing out	7000746	7000756	7000752	400 ml	20 x 5 ml	12.5 x 75	5000	4312
	Swing out	7000746	7000756	7000753	240 ml	20 x 3 ml	11 x 100	5000	4312
	Swing out	7000746	7000756	7000754	120 ml	20 de 1.5 / 2.2 ml	-	5000	4312
	Swing out	7000746	7000756	7000755	undrilled	-	-	5000	4312
7000613	Swing out	-	-	-	-	4 x 96 microtiter	-	4200	2702

*VAC: Blood tube with stopper. Note: All buckets and adapters come without tubes unless stated, see page 132 for tubes and accessories.

HEAD REDUCERS

Reducers for head. Part No. 7000741:

- 7001770 For 1 tube 85 ml (38 Ø x 105 mm).
- 7001771 For 1 tube 50 ml (34 Ø x 100 mm).
- 7001772 For 1 tube 50 ml (29 Ø x 103 mm).
- 7001773 For 1 tube 25 ml (24 Ø x 100 mm).
- 7001774 For 1 tube 30 ml (25 Ø x 100 mm).
- 7001775 For 3 tubes 15 ml (16,5 Ø x 100 mm).
- 7001776 For 3 tubes 10 ml (16 Ø x 80 mm).
- 7001777 For 7 tubes 7 ml (12 Ø x 100 mm).
- 7001778 For 7 tubes 5 ml (12,5 Ø x 75 mm).
- Reducers for head. Part No. 7000742:**
- 7001707 For 1 tube 50 ml (29 Ø x 103 mm).
- 7001708 For 1 tube 25 ml (24 Ø x 100 mm).
- 7001709 For 1 tube 30 ml (25 Ø x 92 mm).
- 7001710 For 1 tube 15 ml (16,5 Ø x 100 mm).

7001780 For 1 tube 10 ml (16 Ø x 80 mm).

7001781 For 4 tubes 7 ml (12 Ø x 100 mm).

7001782 For 4 tubes 5 ml (12,5 Ø x 75 mm).

Reducers for head. Part No. 7001449:

- 7001783 For 1 tube 50 ml (34 Ø x 100 mm).
- 7001784 For 1 tube 50 ml (29 Ø x 103 mm).
- 7001785 For 1 tube 25 ml (24 Ø x 100 mm).
- 7001786 For 1 tube 30 ml (25 Ø x 92 mm).
- 7001787 For 2 tubes 15 ml (16,5 Ø x 100 mm).
- 7001788 For 2 tubes 10 ml (16 Ø x 100 mm).
- 7001789 For 5 tubes 7 ml (12 Ø x 100 mm).
- 7001790 For 5 tubes 5 ml (12,5 Ø x 75 mm).
- Reducers for head. Part No. 7001448:**
- 7001791 For 1 tube 25 ml (24 Ø x 100 mm).
- 7001792 For 1 tube 30 ml (25 Ø x 100 mm).

7001793 For 1 tube 15 ml (16,5 Ø x 100 mm).

7001794 For 1 tube 10 ml (16 Ø x 80 mm).

7001795 For 2 tubes 7 ml (12 Ø x 100 mm).

7001796 For 2 tubes 5 ml (12,5 Ø x 75 mm).

Reducers for head. Part No. 7001447:

- 7001797 For 1 tube 15 ml (16,5 Ø x 100 mm).
- 7001798 For 1 tube 10 ml (16 Ø x 80 mm).
- 7001799 For 1 tube 7 ml (12 Ø x 100 mm).
- 7001800 For 1 tube 5 ml (12,5 Ø x 75 mm).
- Reducers for head. Part No. 7001445/7001446:**
- 7001801 For 1 tube 5 ml (12,5 Ø x 75 mm).
- Reducers for head. Part No. 7000743:**
- 7000700 For 1 tube 7 ml (12 Ø x 100 mm).
- 1001557 For 1 tube 5 ml (12,5 Ø x 75 mm).



Microprocessor controlled Centrifuge "Macrotronic-BLT" and "Macrofriger-BLT"



**Multi-capability. Capacity from 1.5/2.2 ml vials up to tubes of 500 ml and 500ml blood bags.
Maintenance free induction motor drive.**

Control panel features (see page 121).
External case made of DUR-AL alloy with an AISI 304 stainless steel bowl.



Model "Macrotronic-BLT"

Model "Macrofriger-BLT" refrigerated, temperature range -12 °C to 40 °C.

MODEL

Part No.	Max. volume ml	Max. No. of bags	Height / Width / Depth (exterior) cm	Power W	Weight Kg
7001485	2000	4 x 500 ml	45 60 66	720	76

MODEL

Part No.	Max. volume ml	Max. No. of bags	Height / Width / Depth (exterior) cm	Power W	Weight Kg
7001486	2000	4 x 500 ml	97 60 66	1230	156

Note: The rotor being used limits the actual temperature in the chamber due to the speed and ambient temperature. Internal temperature Indicated on the LCD display.

ACCESSORIES

Angle rotors with lid, made of anodised hardened aluminium with identification system. All rotors are autoclavable.



Part No. head	Rotor type	Max. volume	Tube capacity	Ø x Length mm	MACROTRONIC BLT		MACROFRIGER BLT	
					Max. R.p.m	Max. R.c.f. (xg)	Max. R.p.m	Max. R.c.f. (xg)
7000561	Angle+lid	600 ml	12 x 50 ml	34 x 100	4530	3785	4530	3785
7000560	Angle+lid	840 ml	56 x 15 ml	16.5 x 100	4030	3268	4030	3268
7001650	Angle+lid	1500 ml	6 x 250 ml	62 x 122	8000	10373	9000	13129
7001651	Angle+lid	510 ml	6 x 85 ml	38 x 105	10000	10731	12000	15452
7001652	Angle+lid	400 ml	8 x 50 ml	29 x 103	10000	11066	12000	15935
7001653	Angle+lid	360 ml	12 x 30 ml	25 x 92	10000	12296	12000	17706
7001654	Angle+lid	200 ml	20 x 10 ml	16 x 80	10000	11066	12000	15935

Swing out rotor with interchangeable sealed buckets and adapters, each with identification code. Autoclavable.

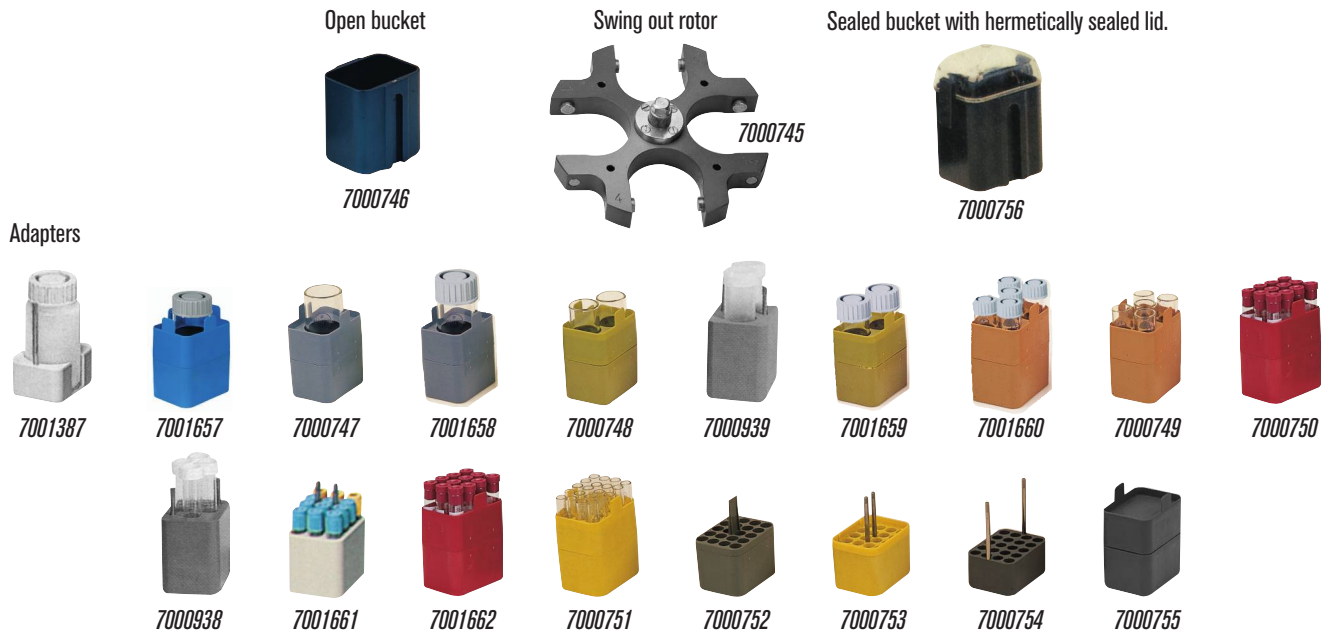

Part No. head	Rotor type	Bucket open	Sealed bucket	Part No. adapter	Total max. Volume (4 adapters)	Bucket/Adapter capacity	Ø x Length mm	Max. R.p.m.	Max. R.c.f. (xg)
7000745	Swing out	7000746	7000756	7001387	800 ml	1 x 200 ml	56.6 x 104	5000	4615
	Swing out	7000746	7000756	7001657	500 ml	1 x 125 ml	51 x 115	5000	4615
	Swing out	7000746	7000756	7000747	400 ml	1 x 100 ml	44 x 104	5000	4615
	Swing out	7000746	7000756	7001658	320 ml	1 x 80 / 85 ml	38 x 105	5000	4615
	Swing out	7000746	7000756	7000748	400 ml	2 x 50 ml	34 x 100	5000	4615
	Swing out	7000746	7000756	7000939	400 ml	2 x 50 ml Falcon	30 x 117	5000	4615
	Swing out	7000746	7000756	7001659	400 ml	2 x 50 ml	29 x 103	5000	4615
	Swing out	7000746	7000756	7001660	600 ml	5 x 30 ml	25 x 92	5000	4615
	Swing out	7000746	7000756	7000749	500 ml	5 x 25 ml	24 x 100	5000	4615
	Swing out	7000746	7000756	7000750	720 ml	12 x 15 ml	16.5 x 100	5000	4615
	Swing out	7000746	7000756	7000750	720 ml	12 VAC*	16.5 x 100	5000	4615
	Swing out	7000746	7000756	7000938	240 ml	4 x 15 ml Falcon	16.5 x 120	5000	4615
	Swing out	7000746	7000756	7001661	-	12 VAC*	13 x 75	5000	4615
	Swing out	7000746	7000756	7001662	480 ml	12 x 10 ml	16.8 x 85	5000	4615
	Swing out	7000746	7000756	7000751	560 ml	20 x 7 ml	12 x 100	5000	4615
	Swing out	7000746	7000756	7000752	400 ml	20 x 5 ml	12.5 x 75	5000	4615
	Swing out	7000746	7000756	7000753	240 ml	20 x 3 ml	11 x 100	5000	4615
	Swing out	7000746	7000756	7000754	120 ml	20 de 1.5 / 2.2 ml	-	5000	4615
Swing out	7000746	7000756	7000755	undrilled	-	-	5000	4615	

*VAC: Blood tube with stopper.

Note: All buckets and adapters come without tubes unless stated, see page 132 for tubes and accessories.

ACCESSORIES



Part No. head	Rotor type	Bucket open	Part No. adapter	Total max. Volume (4 adapters)	Bucket/Adapter capacity	Ø x Length mm	Max. R.p.m.	Max. R.c.f. (xg)
7001450	swing out	7001451	7001395	2000 ml	1 x 500 ml	70 x 165	3200	2358
	swing out	7001451	7001655	1000 ml	1 x 250 ml	62 x 122	3200	2358
	swing out	7001451	7001396	800 ml	1 x 200 ml	56.6 x 104	3200	2358
	swing out	7001451	7001397	800 ml	2 x 100 ml	44 x 104	3200	2358
	swing out	7001451	7001398	800 ml	4 x 50 ml	34 x 100	3200	2358
	swing out	7001451	7001399	900 ml	9 x 25 ml	24 x 100	3200	2358
	swing out	7001451	7001400	1020 ml	17 x 15 ml	16.5 x 100	3200	2358
	swing out	7001451	7001401	672 ml	24 x 7 ml	12 x 100	3200	2358
	swing out	7001656	-	-	3 plates x 96 microtiter	-	3200	2117

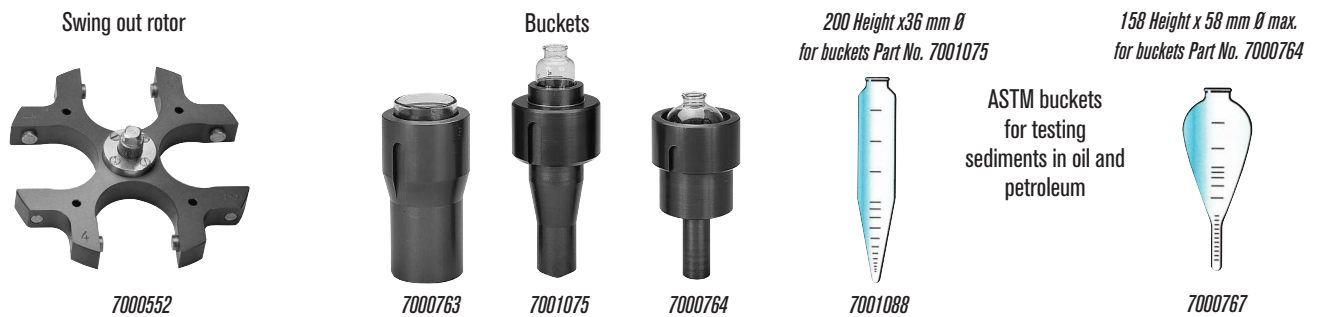

Part No. head	Rotor type	Open Bucket	Total max. Volume (4 adapters)	Bucket/Adapter capacity	Ø x Length mm	Max. R.p.m.	Max. R.c.f. (xg)
7000552	swing out	7000763	1000 ml	1 x 250 ml	56 x 147	3720	3567
	swing out	7001075	4 x 1 ASTM	1 x ASTM cylindrical	36 x 200	3720	3567
	swing out	7000764	4 x 1 ASTM	1 x ASTM pear shaped	58 x 158	3720	3567

Note: All buckets and adapters come without tubes unless stated, see page 132 for tubes and accessories.

HEAD REDUCERS

Reducers for head. Part No. 7001650:

- 7001803 For 1 tube 100 ml (44 Ø x 104 mm).
- 7001804 For 1 tube 85 ml (38 Ø x 105 mm).
- 7001805 For 1 tube 50 ml (34 Ø x 100 mm).
- 7001806 For 2 tubes 50 ml (29 Ø x 103 mm).
- 7001807 For 1 tube 50 ml (30 Ø x 117 mm).
- 7001808 For 3 tubes 30 ml (25 Ø x 92 mm).
- 7001809 For 7 tubes 15 ml (16,5 Ø x 100 mm).
- 7001810 For 7 tubes 10 ml (16 Ø x 100 mm).
- 7001811 For 12 tubes 7 ml (12 Ø x 100 mm).
- 7001812 For 12 tubes 5 ml (12,5 Ø x 75 mm).

Reducers for head. Part No. 7001651:

- 7001783 For 1 tube 50 ml (34 Ø x 100 mm).
- 7001784 For 1 tube 50 ml (29 Ø x 103 mm).
- 7001785 For 1 tube 25 ml (24 Ø x 100 mm).
- 7001786 For 1 tube 30 ml (25 Ø x 92 mm).
- 7001787 For 2 tubes 15 ml (16,5 Ø x 100 mm).
- 7001788 For 2 tubes 10 ml (16 Ø x 100 mm).
- 7001789 For 5 tubes 7 ml (12 Ø x 100 mm).
- 7001790 For 5 tubes 5 ml (12,5 Ø x 75 mm).

Reducers for head. Part No. 7001652:

- 7001791 For 1 tube 25 ml (24 Ø x 100 mm).
- 7001792 For 1 tube 30 ml (25 Ø x 100 mm).

7001793 For 1 tube 15 ml (16,5 Ø x 100 mm).

- 7001794 For 1 tube 10 ml (16 Ø x 80 mm).
- 7001795 For 2 tubes 7 ml (12 Ø x 100 mm).
- 7001796 For 2 tubes 5 ml (12,5 Ø x 75 mm).

Reducers for head. Part No. 7001653:

- 7001797 For 1 tube 15 ml (16,5 Ø x 100 mm).
- 7001798 For 1 tube 10 ml (16 Ø x 80 mm).
- 7001799 For 1 tube 7 ml (12 Ø x 100 mm).
- 7001800 For 1 tube 5 ml (12,5 Ø x 75 mm).

Reducers for head. Part No. 7000560:

- 7000700 For 1 tube 7 ml (12 Ø x 100 mm).
- 1001557 For 1 tube 5 ml (12,5 Ø x 75 mm).



Refrigerated high capacity microprocessor controlled centrifuge suitable for tubes, flasks and blood bags “Megafriger-BLT-Blood” and “Macrofriger-BLT-Blood”



Original J.P. Selecta design. With maintenance free induction drive motor

SAFETY:
SAFETY, CONFORMS TO UNE-EN 61010-2-020.
PROTECTIVE INTERNAL CYLINDER BETWEEN THE CASE AND BOWL.
THE LID CANNOT BE OPENED WHILE THE ROTOR IS SPINNING.
THE MOTOR CANNOT SPIN WHILE THE LID IS OPEN.

IMBALANCE DETECTOR, AUTOMATICALLY STOPS IF THERE IS ANY IMBALANCE.
DOUBLE ELECTROMAGNETIC LID LOCK.
IF THERE IS A POWER FAILURE, A FAIL SAFE SYSTEM CAN BE USED TO OPEN THE LID.
EMERGENCY STOP BUTTON.

COMMON FEATURES

- 7” TFT touch screen.
- Furniture: aluminum structure in Megafriger model and in steel tube with Dur-Al sides in Macrofriger model.
- Internal Stainless steel bowl .
- Aluminium windbreak cover.
- Safety shield: 8 mm thick steel.
- Swing-out rotor, buckets and adapters made of high-density material, engraved identification unalterable.
- Suspended motor with silent-block and shock absorbers that guarantee smooth, quiet operation without vibrations.
- Drive force: equipped with an induction drive maintenance free and highly efficient pollution free motor.
- Semi-hermetically sealed, compressor pollution free with no hydrocarbons or fluoro-carbons.
- Mounted on an anti vibration adjustable rubber feet.
- Microprocessor digital control of all functions: speed, acceleration, brake, R.C.F., temperature, time, 10 program memory, rotor identification, operation fault alarm.
- Digital indicator of the rotor and blood bag buckets operating hours.**

APPLICATIONS

- Specially designed for blood bank applications, where repeatability, precision and reliability of: speed, time, temperature, acceleration and deceleration are significant factors in obtaining perfect separations of the distinct blood fractions.
- Serology investigations.
- Molecular biology.
- Serum separation, pharmaceutical applications.

CONTROL PANEL

Touch screen

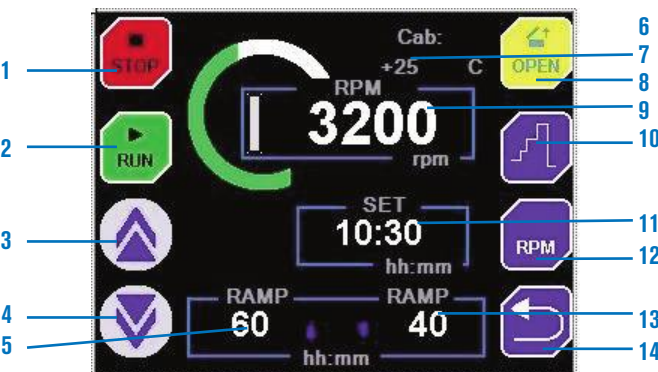

- | | |
|---|----------------------------------|
| 1. Stop process key. | 8. Door opening key. |
| 2. Start process key. | 9. RPM or RCF real-time reading. |
| 3. Increase value key. | 10. Sequential operation. |
| 4. Decrease value key. | 11. Time set-up in process. |
| 5. Scheduled acceleration ramp. | 12. Key to change RPM / RCF. |
| 6. Rotor model in use. | 13. Braking ramp programmed. |
| 7. Reading the real time temperature. (refrigerated models only). | 14. Return key.. |

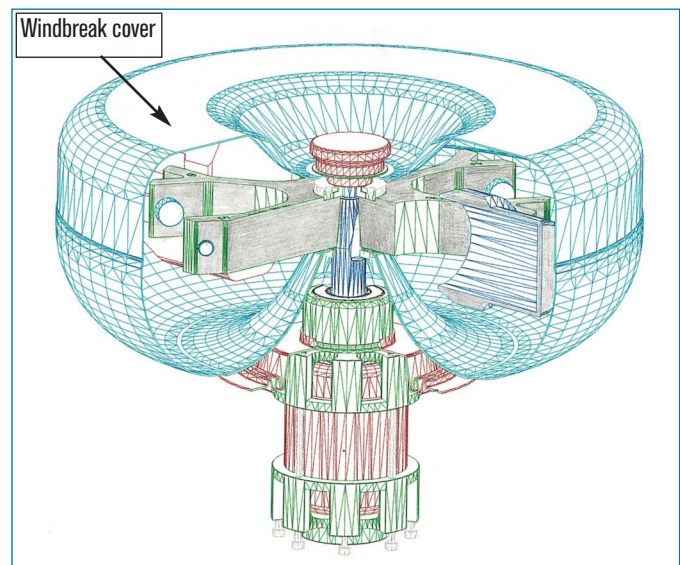
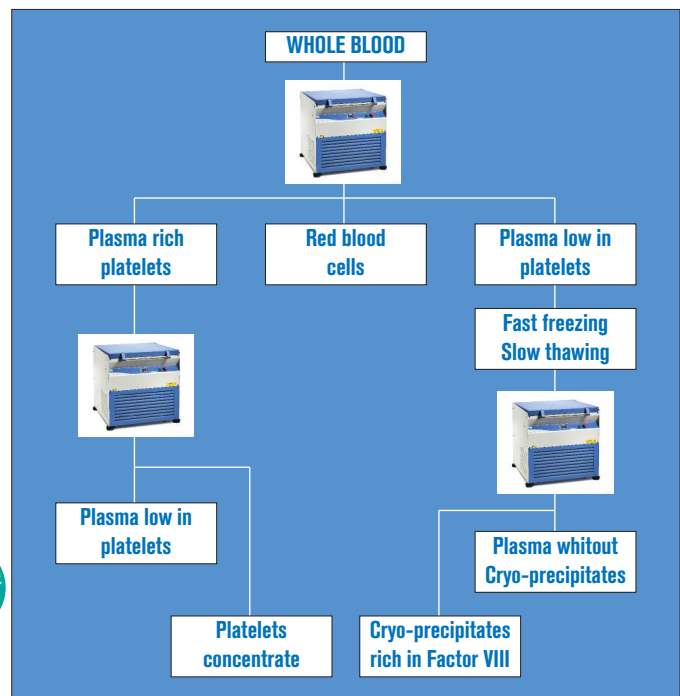

Cross-section of the motor, rotor drive mechanism, showing the windbreak protector with lid that reduces the air resistance and maintains a regulated temperature.



Refrigerated high capacity microprocessor controlled centrifuge suitable for tubes, flasks and blood bags “Megafriger-BLT-Blood”

ADJUSTABLE WORKING TEMPERATURES FROM -10 TO 40 ° C. (TEMPERATURE AT STANDSTILL -20 ° C).
CAPACITY UP TO 1000 ML BOTTLES AND SPECIAL FOR BLOOD BAGS OF 500 TO 800 ML.
MAXIMUM CAPACITY 4 BAGS.

NEW



Swing out rotor 4 places detail



Features and control panel (see page 129).

TECHNICAL SPECIFICATION

Maximum volume:4000 ml
Maximum bucket volume:1000 ml
Speed 7001488:	from 300 to 4600 r.p.m.
Accuracy:	± 5 r.p.m.
Resolution r.p.m.:10 r.p.m.
R.C.F.:	from 24 to 5700
Imbalance:	± 5 g
Accuracy:4 g
Temperature range:	from -10 °C to 40 °C
Temperature stability:	±4 °C
Resolution:1 °C
Temperature range:99 min. 59 sec.
Centrifuge radius:241 mm
Acceleration profile:5
Brake profile:9 linear 6 quadratic
Voltage:230.
Power:1700 VA

MODEL

Part No.	Max. Volume ml	Max. Capacity	Height / Width / Depth (exterior) cm	Power W	Weight Kg
7001488	4000	4 bags x 1000 ml	97 70 72	1700	190

ACCESSORIES FOR PART NO. 7001490

Swing out rotor 4 places, treated steel.



Part No. **7001343**

Interchangeable buckets and reducers with identification sign. Autoclavable.



Single bucket.
Bags of 500 to 800 ml.
Part No. **7001344**



Single bucket.
Capacity: 1 blood bag of 500 to 800 ml or 1 flask of 1 litre or with tube adapters.
Part No. **7001393**

Adapters for single bucket Part No. 7001393.

Bottle



1001394



7001395



7001396



7001397



7001398



7001399



7001400



7001401

Single Bucket	Part No. adapter	Total max. Volume (4 adapters)	Capacity: bags, tubes by adapter	Ø x Length mm	R.p.m. Min./Max.	R.c.f. (xg) Min./Max.
7001344	-	3200 ml	2 bag 500 or 800 ml	-	300/4600	24/5520
7001393 Capacity without adapter: 1 bag of 500 to 800 ml or 1x bottle 1000 ml	Bottle 1000 ml 1001394	4000 ml	1 bottle 1000 ml or 1 bag	98 x 175	300/4600	24/5520
	7001395	2000 ml	1 bottle 500 ml	70 x 165	300/4600	24/5520
	7001396	800 ml	1 bottle 200 ml	56.6 x 104	300/4600	24/5520
	7001397	800 ml	2 tubes 100 ml	44 x 104	300/4600	24/5520
	7001398	800 ml	4 tubes 50 ml	34 x 100	300/4600	24/5520
	7001399	900 ml	9 tubes 25 ml	24 x 100	300/4600	24/5520
	7001400	1020 ml	17 tubes 15 ml	16.5 x 100	300/4600	24/5520
	7001401	672 ml	24 tubes 7 ml	12 x 100	300/4600	24/5520

Note: All buckets and adapters come without tubes, see page 132 for tubes and accessories. Other adapters can be manufactured as per customers specification.

COMPLEMENTS



Blood bank refrigerated cabinets "Blood Bank" A, C and D

FORCED AIR CIRCULATION.
FIXED TEMPERATURE +4 °C. STABILITY ±1.5 °C. RESOLUTION 1 °C.
SEVEN DAYS GRAPHIC TEMPERATURE REGISTER.
CAPACITIES FROM 80 TO 480 BLOOD BAGS.

FEATURES

See page. 79



MODELS	Part No.	Capacity litres	Capacity bags	Height / Width / Depth (interior) cm	Height / Width / Depth (exterior) cm	Power W	Power HP	Number of shelves	Weight Kg
Blood Bank A	2101519	235	80	109 51 55	156 61 62	300	1/7	4	90
Blood Bank C	2101512	560	200	153 54 66	213 80 79	497	3/8	4	165
Blood Bank D	2101514	1240	480	153 124 68	213 139 79	1034	5/8	8	212

They are supplied with trays.



Refrigerated high capacity microprocessor controlled centrifuge suitable for tubes, flasks and blood bags “Macrofriger-BLT-Blood”

ADJUSTABLE WORKING TEMPERATURES FROM 0 TO 40 ° C. (TEMPERATURE AT STANDSTILL -20 ° C).
CAPACITY UP TO 1000 ML BOTTLES AND SPECIAL FOR TRIPLE AND QUADRUPLE BLOOD BAGS OF 500 TO 800 ML.
MAXIMUM CAPACITY 12 BAGS.



Image showing the rotor and double buckets for quad and triple blood bags of 500 and 800 ml.

Features and control panel (see page 129).

TECHNICAL SPECIFICATION

Maximum volume:	9600 ml
Maximum bucket volume:	1600 ml
Speed 7001490:	from 300 to 4070 r.p.m.
Accuracy:	± 5 r.p.m.
Resolution r.p.m:	10 r.p.m.
R.C.F.:	from 29 to 5430
Imbalance:	± 5 g
Accuracy:	4 g
Temperature range:	from -20 °C to 40 °C
Temperature stability:	±4 °C
Resolution:	1 °C
Temperature range:	99 min. 59 sec.
Centrifuge radius:	290 mm
Acceleration profile:	5
Brake profile:	9 linear 6 quadratic
Voltage:	230/400 three phase.
Power:	4500 VA

MODEL

Part No.	Max. Volume ml	Max. Capacity	Height / Width / Depth (exterior) cm	Power W	Weight Kg
7001490	9600	12 bags x 800 ml	105 96 96	5500	420



ACCESSORIES FOR PART NO. 7001490

Swing out rotor 6 places, treated steel.



Part No. **7001391**

Interchangeable buckets and reducers with identification sign. Autoclavable.



Buckets with two compartments for blood bags of 500 to 800 ml. For triple and quad bags
Part No. **7001392**



Single bucket.
Capacity: 1 blood bag of 500 to 800 ml or 1 flask of 1 litre or with tube adapters.
Part No. **7001393**

Bags holder set for double cup 7001392
Part No. **0928292**

Adapters for single bucket Part No. 7001393.

Bottle



1001394



7001395



7001396



7001397



7001398



7001399



7001400



7001401

Double Bucket	Single Bucket	Part No. adapter	Total max. Volume (6 adapters)	Capacity: bags, tubes by adapter	Ø x Length mm	R.p.m. Min./Max.	R.c.f. (xg) Min./Max.
7001392	-	-	9600 ml	2 bags 500 or 800 ml	-	300/4070	29/5450
-	-	Bottle 1000 ml 1001394	6000 ml	1 bottle 1000 ml or 1 bag	98 x 175	300/4070	29/5430
-	7001393	7001395	3000 ml	1 bottle 500 ml	70 x 165	300/4070	29/5430
-	Capacity	7001396	1200 ml	1 bottle 200 ml	56.6 x 104	300/4070	29/5430
-	without adapter:	7001397	1200 ml	2 tubes 100 ml	44 x 104	300/4070	29/5430
-	1 bag of	7001398	1200 ml	4 tubes 50 ml	34 x 100	300/4070	29/5430
-	500 to 800 ml	7001399	1350 ml	9 tubes 25 ml	24 x 100	300/4070	29/5430
-	or 1x bottle	7001400	1530 ml	17 tubes 15 ml	16.5 x 100	300/4070	29/5430
-	1000 ml	7001401	1008 ml	24 tubes 7 ml	12 x 100	300/4070	29/5430

Note: All buckets and adapters come without tubes, see page 132 for tubes and accessories.
Other adapters can be manufactured as per customers specification.

ACCESSORIES FOR PART NO. 7001490

Swing out rotor 4 places, treated steel.



Part No. **7001394**

Biological single bucket safety with screw cap for 2 bags of 450 ml blood or 1 bag of 1200 ml.



Part No. **7001330**



7001331

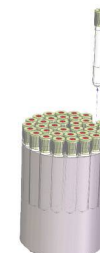

7001332



7001333

Double Bucket	Single Bucket	Part No. adapter	Total max. Volume (4 adapters)	Capacity: bags, tubes by adapter	Ø x Length mm	R.p.m. Min./Max.	R.c.f. (xg) Min./Max.
-	7001330	-	4800 ml	2 bags of 450 or 1 of 1200 ml	-	300/4070	32/5944
-	Capacity	7001331	1600 ml	8 x 50 ml falcon tubes	34 x 120	300/4070	27/4944
-	without adapter: 2 bags	7001332	2100 ml	35 x 15 ml VAC tubes	15,5 x 100	300/4070	25/4722
-	of 450 ml or 1 of 1200 ml	7001333	700 ml	35 x 5 ml VAC tubes	12,5 x 75	300/4070	24/4444

COMMON ACCESSORIES. Tubes of glass and plastic.

Plastic tubes and flasks with screw cap lids.

Volume ml	Dimensions mm	Type	Part No.	Material	Max. (xg) range	Temperature °C
10	16 Ø x 80	Comecta	5752399	Polypropylene	50000	4 ... 121
		Herolab	5752421	Polypropylene	57000	-180 ... 145
		Herolab	5752401	Polycarbonate	57000	-150 ... 121
30	25 Ø x 92	Comecta	5752398	Polypropylene	50000	4 ... 121
		Herolab	5752955	Polypropylene	64000	-180 ... 145
		Herolab	5752951	Polycarbonate	64000	-150 ... 121
50	29 Ø x 103	Comecta	5752397	Polypropylene	50000	4 ... 121
		Herolab	5753205	Polypropylene	69000	-180 ... 145
		Herolab	5753201	Polycarbonate	69000	-150 ... 121
80	38 Ø x 105	Comecta	5752396	Polypropylene	40000	4 ... 121
		Herolab	5753243	Polypropylene	50000	-180 ... 145
		Herolab	5753241	Polycarbonate	50000	-150 ... 121
200	56.6 Ø x 104	Herolab	5715202	Polypropylene	10000	-180 ... 145
		Herolab	5715203	Polycarbonate	10000	-150 ... 121
		Comecta	5752395	Polypropylene	13200	4 ... 121
250	62 Ø x 122	Herolab	5753411	Polypropylene	33000	-180 ... 145
		Herolab	5753401	Polycarbonate	33000	-150 ... 121
		Herolab	5753512	Polypropylene	14000	-180 ... 145
500	70 Ø x 165	Herolab	5753501	Polycarbonate	14000	-150 ... 121
		Herolab	5752571	Polypropylene	4936	-180 ... 145
1000	98 Ø x 175	Herolab	5752561	Polycarbonate	4936	-150 ... 121



Type HEROLAB polycarbonate tubes transparent Polypropylene tubes translucent. Autoclavable.

Type COMECTA polypropylene translucent. Autoclavable.



Glass Tubes.

Volume	Dimensions mm	Part No.
Micro-haematocrit*	1.4 Ø x 75	7000910
7 ml	12 Ø x 100	7000773
15 ml	16.5 Ø x 100	7000772
25 ml	24 Ø x 100	7000771
50 ml	34 Ø x 100	7000770
100 ml	44 Ø x 104	7000769
250 ml	56 Ø x 147	7000768
ASTM	Conical	7001088
ASTM	Pear shape	7000767

*Box of 100 tubes.

SPARE

Buckets for angle rotors.

Suitable for model	Part No. 7001403 15 ml plastic	Part No. 7001500 15 ml plastic	Part No. 7005000 50 ml metal	Part No. 7001000 100 ml metal
Gencom II Part No. 7002240	Yes			
Centro-8 Part No. 7002356		Yes		
Centromix BLT Part No. 7002556			Rotor 7000550	
Meditronic BLT Part No. 7001476			Rotor 7000743	Rotor 7000742
Medifriger BLT Part No. 7001477			Rotor 7000743	Rotor 7000742
Macrotronic BLT Part No. 7001485			Rotor 7000560	Rotor 7000561
Macrofriger BLT Part No. 7001486			Rotor 7000560	Rotor 7000561

ALL THE ROTORS, BUCKETS AND ADAPTERS COME WITH LASER ETCHED IDENTIFICATION.

ACCESSORIES for cytology

Description	Part No.
1. Slide clip fastener	5004050
2. Sample container	5004051
3. Two samples container	5004052
4. Filter	5004053
5. Cyto slide of 1 circle	5004054
6. Cyto slide of 2 circles	5004055
7. Disposable container 1 sample	5004056
8. Disposable container 2 samples	5004057

